

Sistemi i profili za izradu kliznih plakarskih vrata

europrofil

Sistem za izradu Walk In garderobnih soba

Univer/MDF
18mm
25mm

±15mm

WI vertikalni profil AL NE L=2.7m

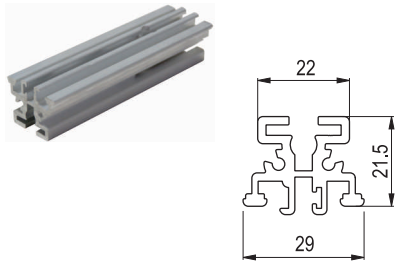

šifra
m Neeloks. 8283

Prodajna dužina profila: 2.70m

WI PVC spojnica vert. profila i ispune



šifra
kom Meč.prov. 8293

WI nogica i podloška za nogicu



šifra
kom metal 8287

Nogica

šifra
kom metal 8286

Podloška

WI ravni veznik vertikalnog profila



šifra
kom metal 8285

WI ugaoni veznik vertikalnog profila

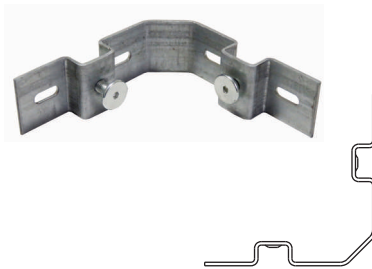

šifra
kom metal 8284

WI skriveni nosači fioke ANT



šifra
set Antracit 8291

WI set za montažu police - Bočno



šifra
set crna/metal 8297

WI set za montažu police - Centralno



šifra
set crna/metal 8298

WI «L» granični profil za policu za cipele

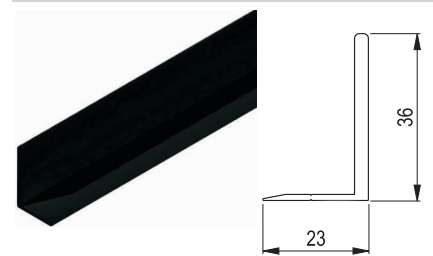

šifra
m crna 8292

Prodajna dužina profila: 3m

WI profil za izradu garderobne šipke AL



šifra
m crna 8294

WI bočni nosač za garderobnu šipku

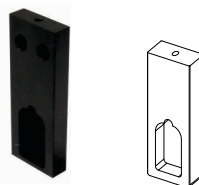

šifra
kom crna 8295

WI guma za garderobnu šipku



šifra
m crna 8295

Sistem za izradu Walk In garderobnih soba

Univer/MDF
18mm
25mm

±15mm

WI ravni nosač police L=350mm ANTRACIT

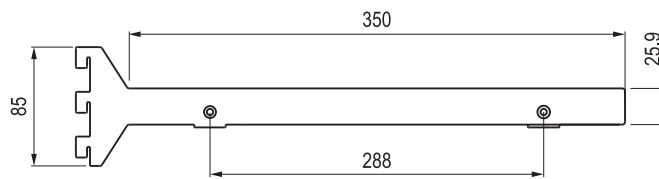

		šifra
kom	Antracit	8288
L=350mm		

WI ravni nosač police L=508mm ANTRACIT

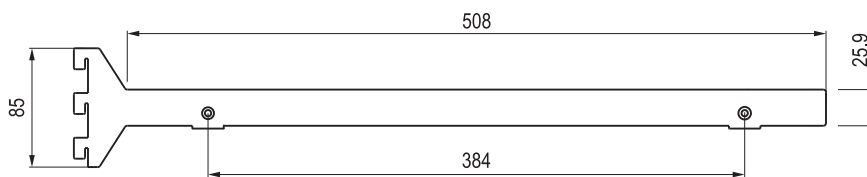

		šifra
kom	Antracit	8289
L=508mm		

WI kosi nosač police L=508mm ANTRACIT

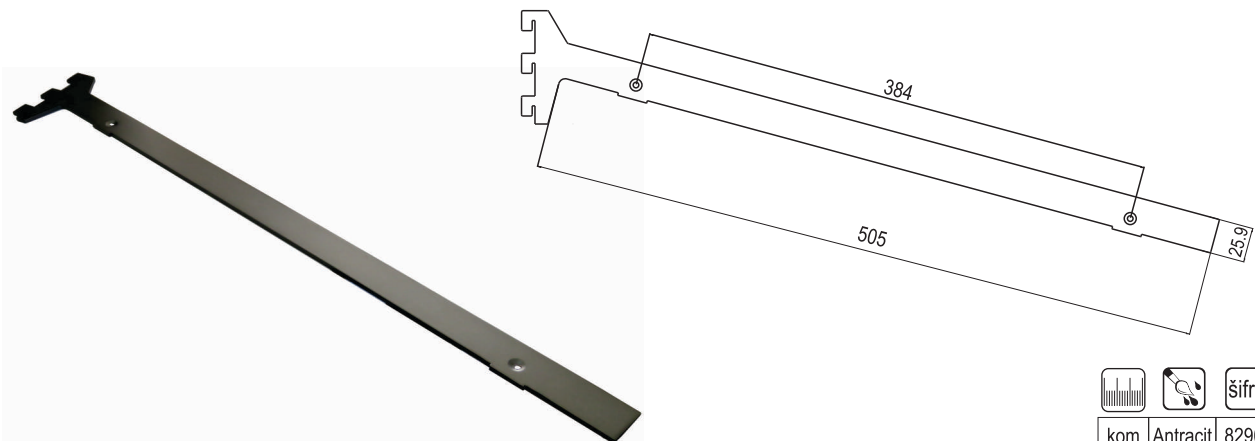

		šifra
kom	Antracit	8290
L=508mm		

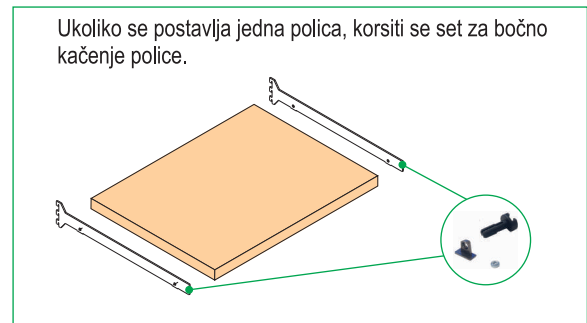
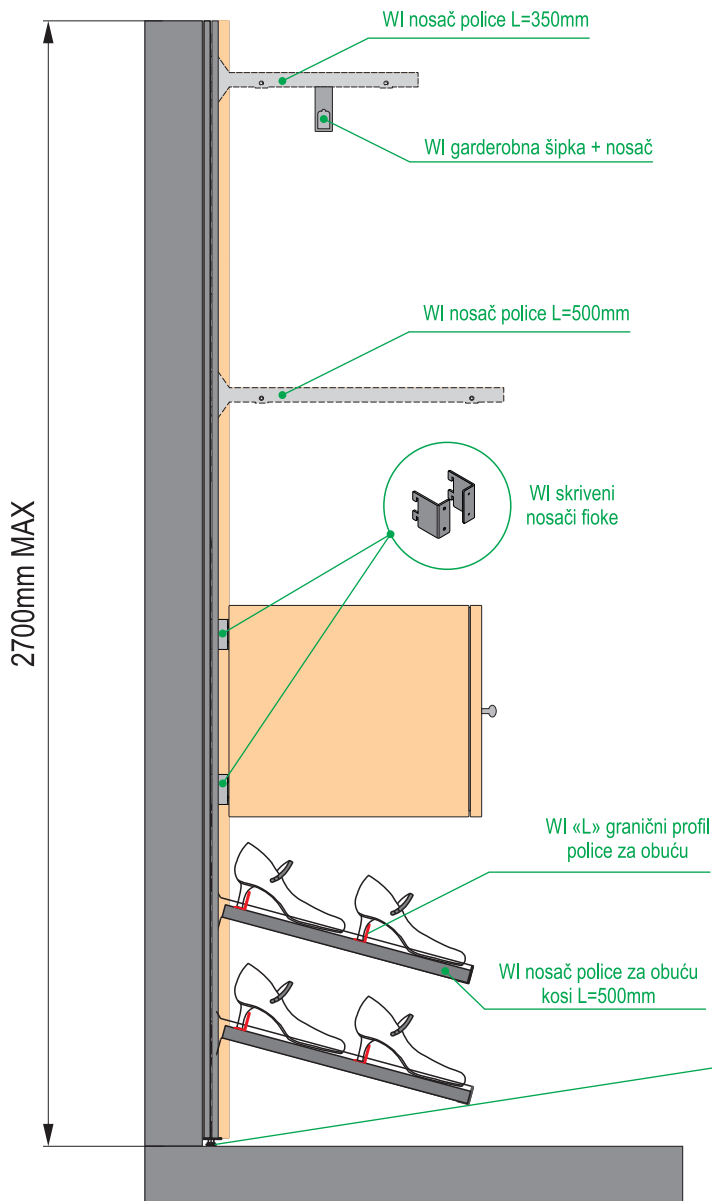

Podšavajuća nogica i podloška za nogicu

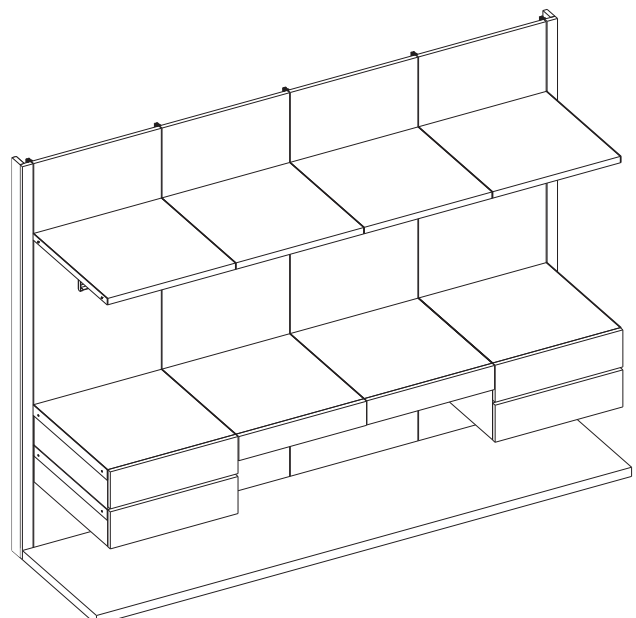
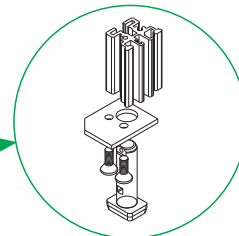

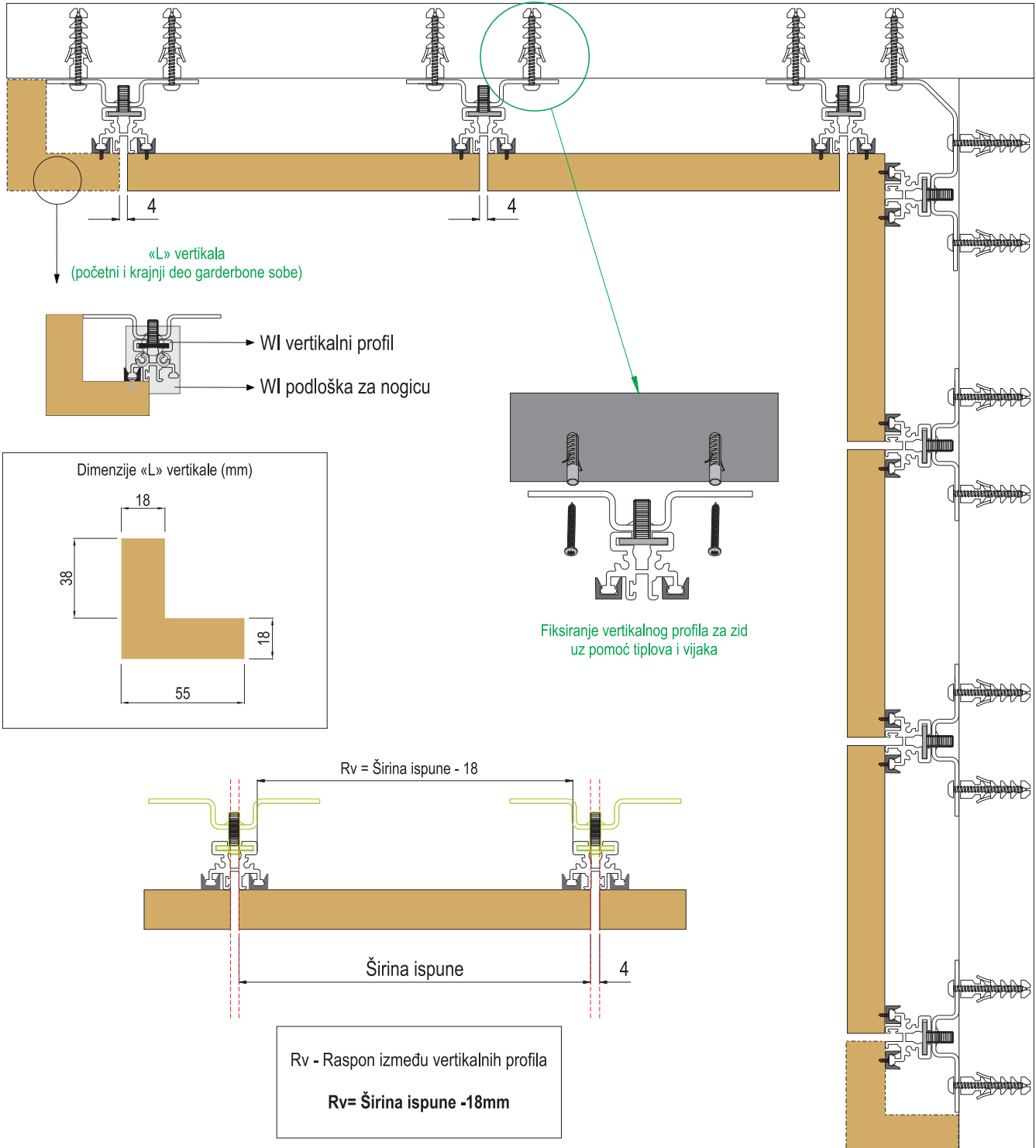

Nosači vertikalnog profila se vezuju za ledja ispune sa vijcima a kao distanca od ivice ispune se koristi pero koje je integrisano na sam nosač.

Nakon postavljanja nosača vertikale na ledja ispune potrebno je ukloniti pero kako ne bi smetalo prilikom kačenja elemenata za vertikalni profil.

Preporuka je da se postavlja 10 komada do visine 2400mm, a za visinu do 2700 do 16 komada nosača po jednom vertikalnom profilu.

